

# TITANIA

design Alberto Meda / Paolo Rizzatto

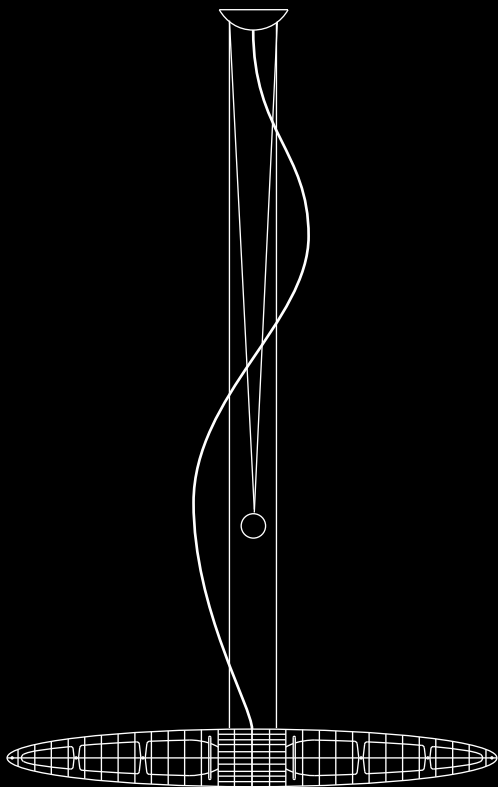

**LUCE  
PLAN**

D17



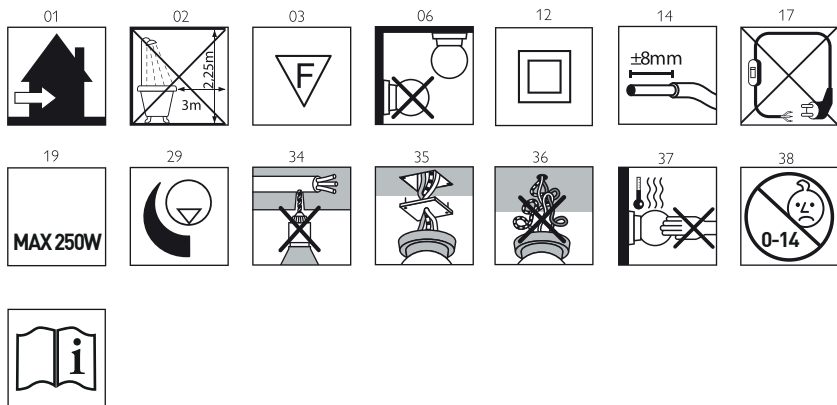

D17



a



b

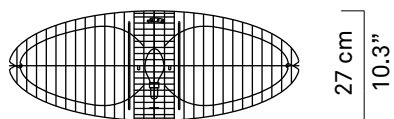
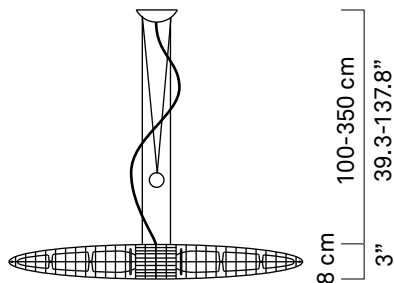

x1



x1



x2



x1



x1



x1

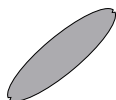

x10

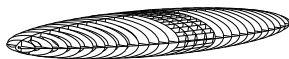

x1



x1

**kg** 1,3 kg

**lb** 2.9 lb



max 250W  
E27



205W  
HSGST/F  
E27  
energy saver



23W  
FBT  
E27  
h max 12 cm - 4.8"  
ø 4,5 cm - 1.8"

## D13/25

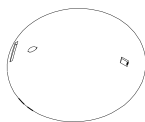

x1

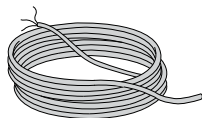

x1

(300 cm - 118")

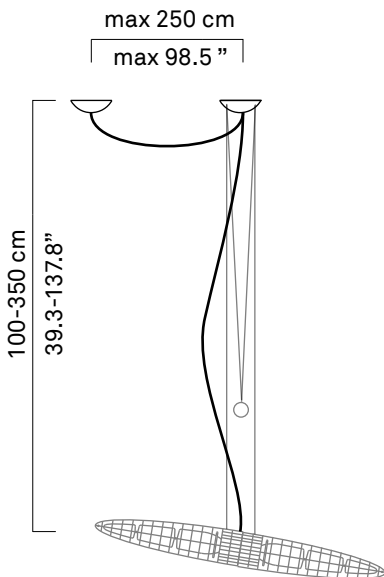

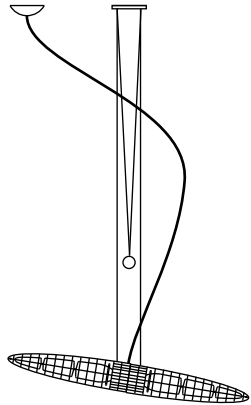
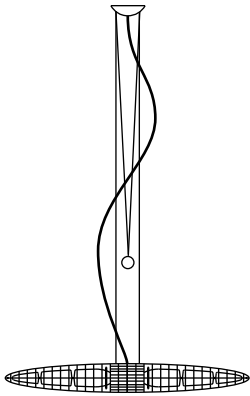

---

D17 + D13/25

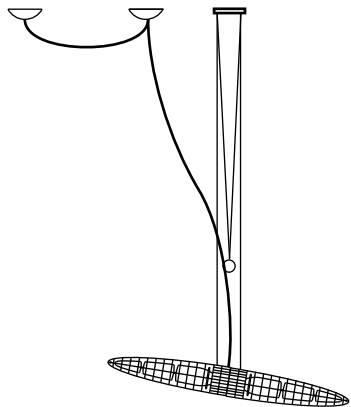
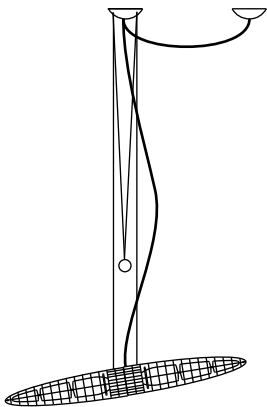

1

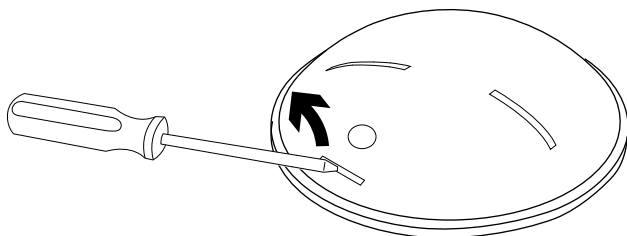

1.1

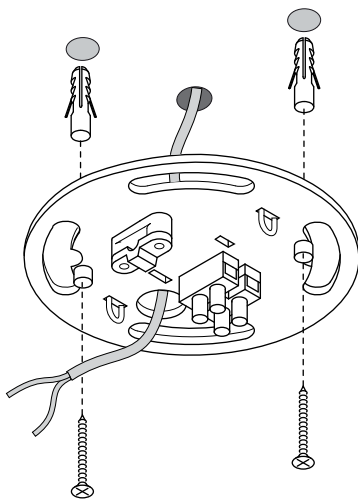
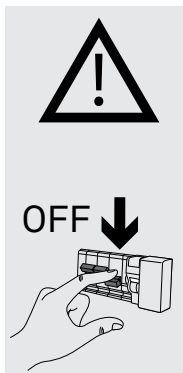

# 1.2

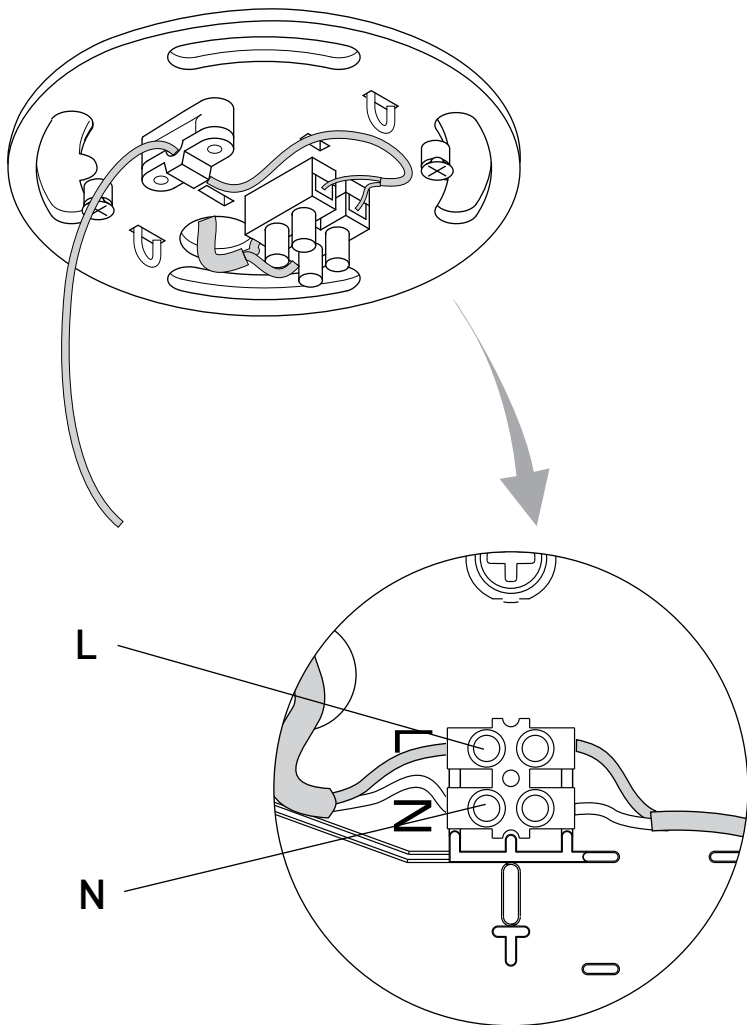

## 2

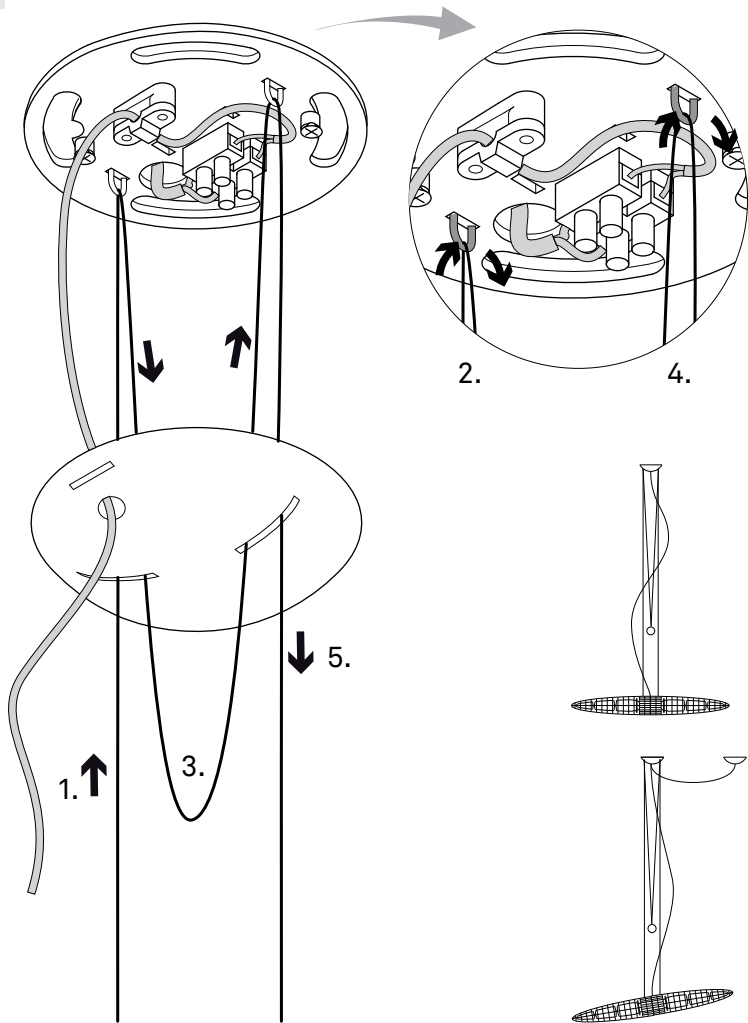



---

2.1

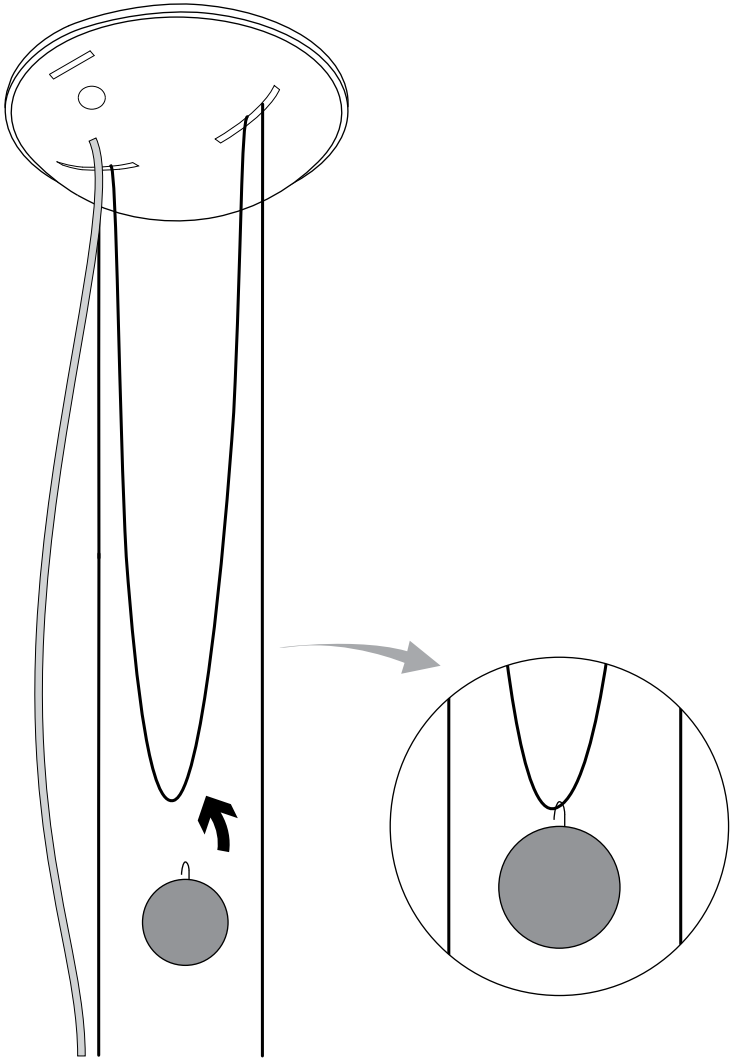

3

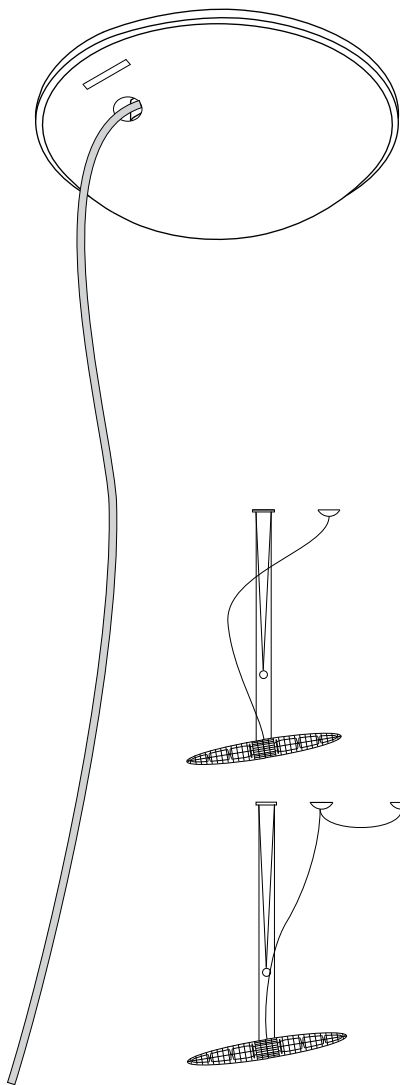
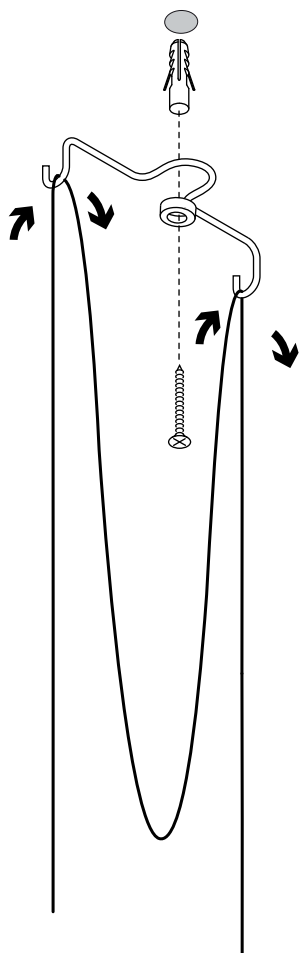

# 3.1

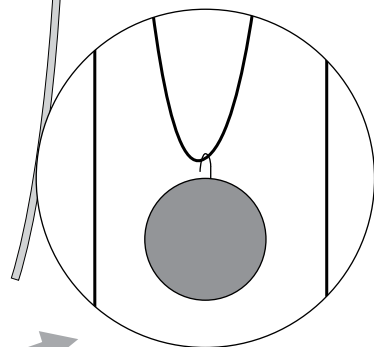
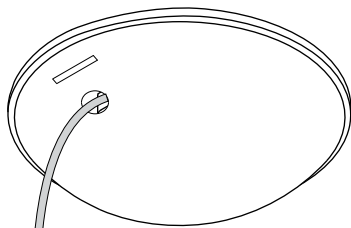
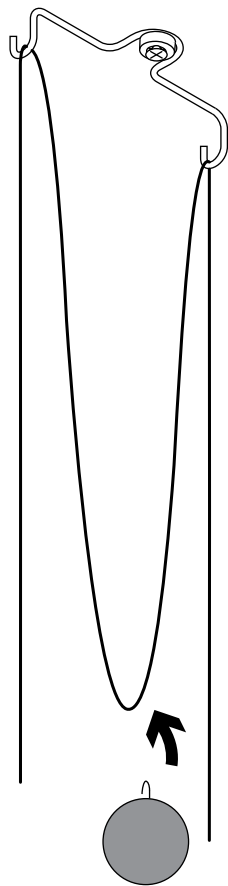

4 x2

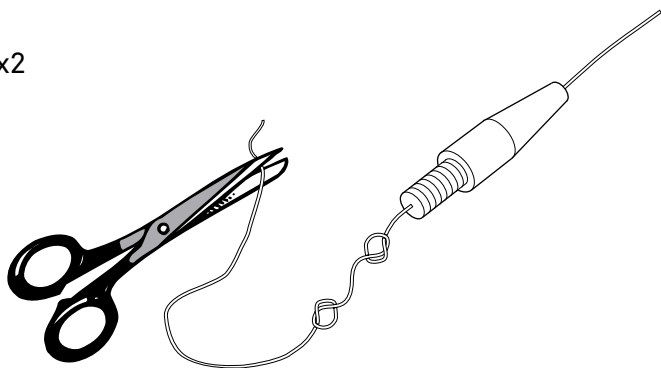

4.1

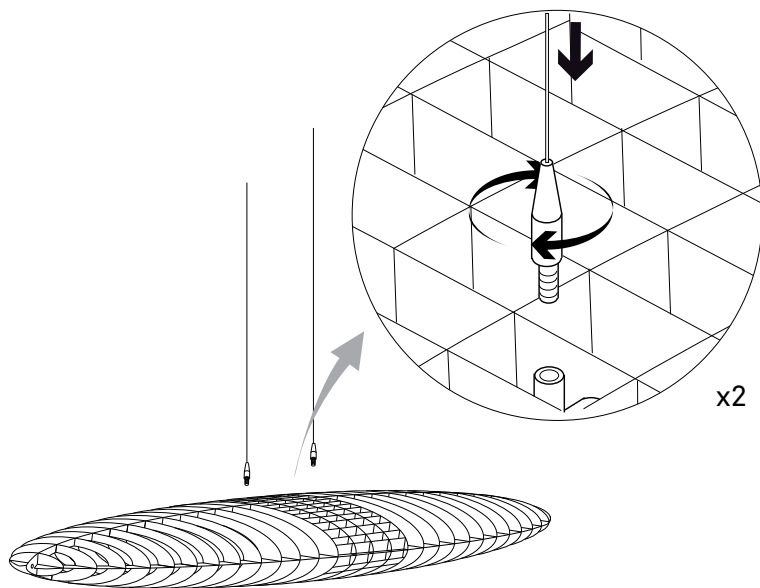

---

## 4.2

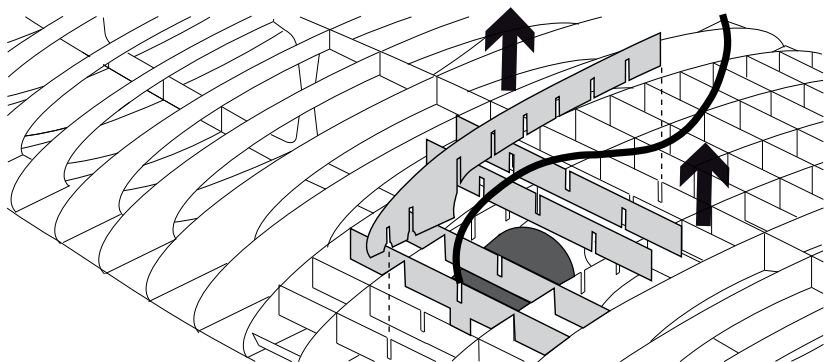

---

## 4.3

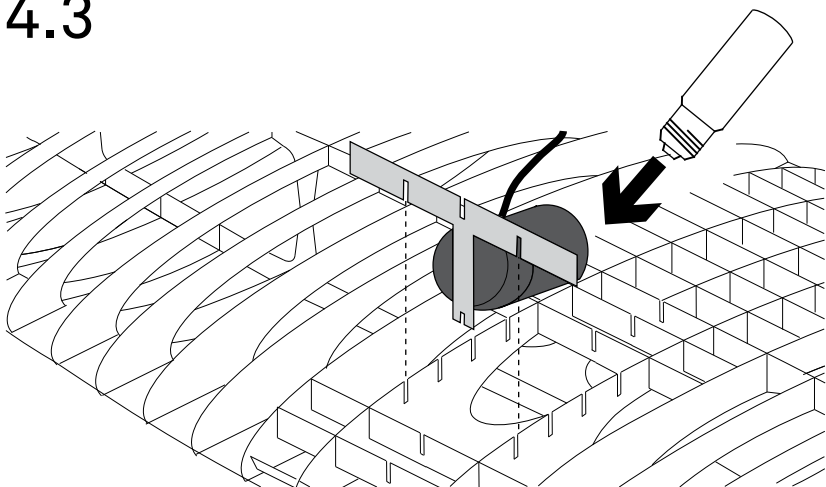

## 4.4

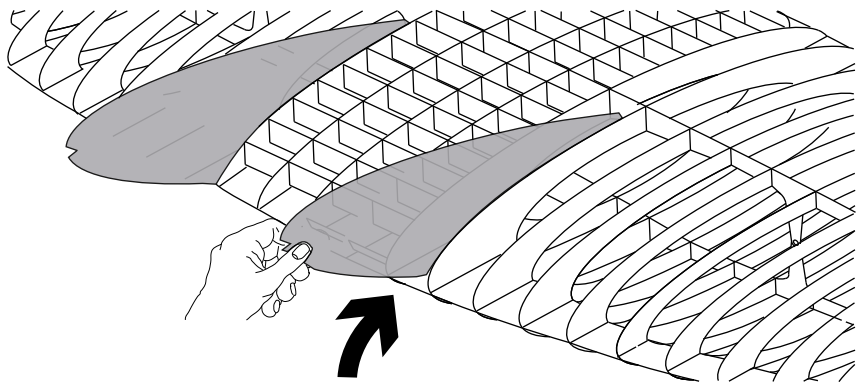
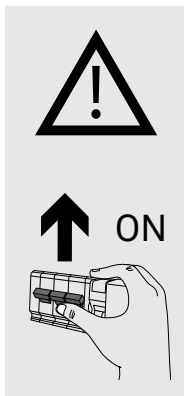
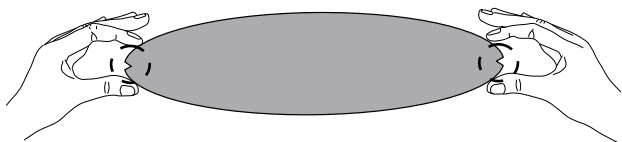





[www.luceplan.com](http://www.luceplan.com)

D170IA203